

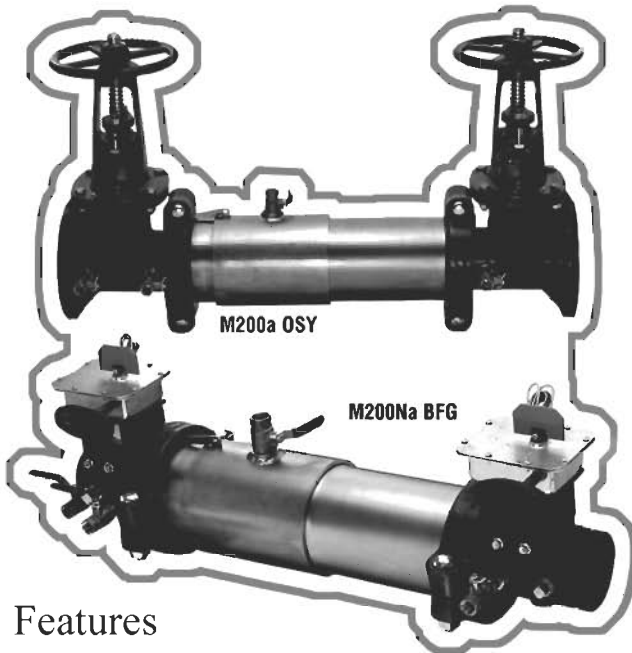

Model M200a / M200Na Double Check Valve Assemblies 2-1/2" to 4"



Features

- Extremely Compact Design
- 70% Lighter than Traditional Designs
- 304 (Schedule 40) Stainless Steel Housing & Sleeve
- Groove Fittings Allow Integral Pipeline Adjustment
- Patented Bi-Link Checks Provides Lowest Pressure Loss
- Unmatched Ease of Serviceability
- Available with Grooved Butterfly Valve Shutoffs
- Replaceable Check Disc Rubber

Materials

- Housing & Sleeve: 304 (Schedule 40) Stainless Steel
- Elastomers: EPDM, Silicone and Buna 'N'
- Tri-Link Checks: Noryl®, Stainless Steel
- Check Discs: Reversible EPDM
- Test Cocks: Bronze Body Nickel Plated
- Pins & Fasteners: 300 Series Stainless Steel
- Springs: Stainless Steel

Pressure — Temperature

Temperature Range: 33°F – 140°F
Maximum Working Pressure: 175psi

Approvals

ASSE 1015, UL Listed 28S6, CSA B64.5, FM Approved, USC Approved.

MAXIM SERIES

Models

- OSY - UL/FM outside stem and yoke resilient seated gate valves
- BFG - UL/FM grooved gear operated butterfly valves w/tamper switch
- NRS - non-rising stem resilient seated gate valves

Configurations

- Horizontal
- Vertical up
- "N" pattern horizontal

Specifications

The Maxim M200a/M200Na Double Check Valve Assemblies are used to prevent backflow of pollutants, that are objectionable but not toxic, from entering the potable water supply system. The Maxim M200a/M200Na may be installed under continuous pressure service and may be subjected to back-pressure. For use in non-health hazard applications. The Double Check Valve Assemblies shall consist of two independent Bi-Link Check modules within a single housing, sleeve access port, four test cocks and two drip tight shutoff valves. The housing shall be constructed with groove end connections. Bi-Link Checks shall produce drip tight closure against the reverse flow of liquid.

Installation

The system should be flushed before the valve is installed. The Series M200a/M200Na must be installed in accordance with the direction of the flow arrow on the assembly and according to the local water authority. The assembly should be installed with adequate clearance to allow inspection, testing and servicing. 12" should be the minimum clearance above grade.

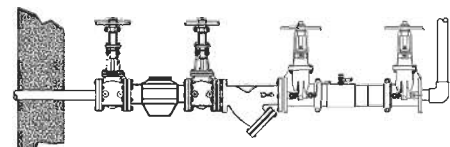

Horizontal Installation

Flow Curves

• = Rated flow ** = UL Tested

— Horizontal — Vertical - - - - N-Pattern

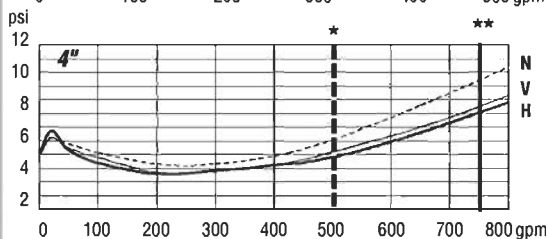
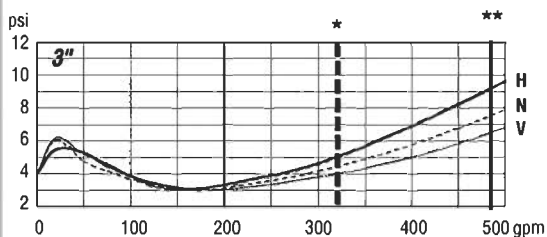
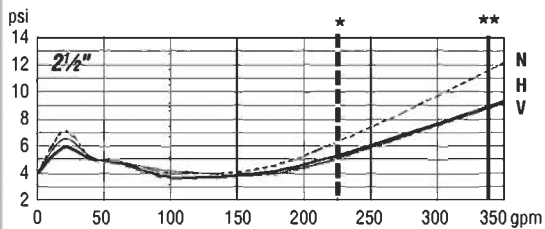

Dimensions — Weights

M200a/M200Na

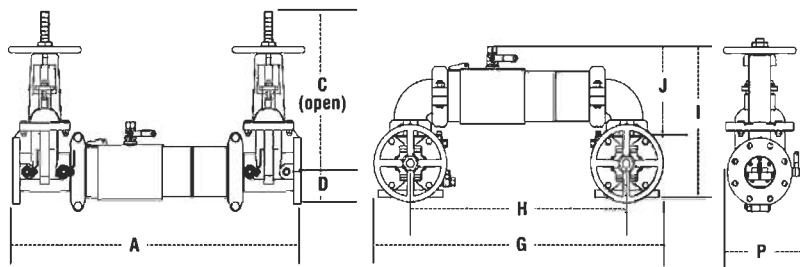

M200a/M200Na

SIZE (DN)	DIMENSIONS								WEIGHT						
	A	C (OSY)	C (NRS)	D	G	H	I	J	P	M200aOSY	M200aNRS	M200NaOSY	M200NaNRS		
2 1/2	31	16 3/8	9 3/8	3 1/2	29 1/16	22 3/4	15 13/16	8 13/16	9 3/16	125	115	133	60	122	55
3	31 11/16	18 7/8	10 1/4	3 11/16	30 1/2	22 3/4	17 1/8	9 3/16	10 1/2	145	131	158	72	144	65
4	40 1/2	22 3/4	12 3/16	5	39 3/4	30 3/4	20 3/8	11 11/16	11 3/16	219	219	242	110	242	110

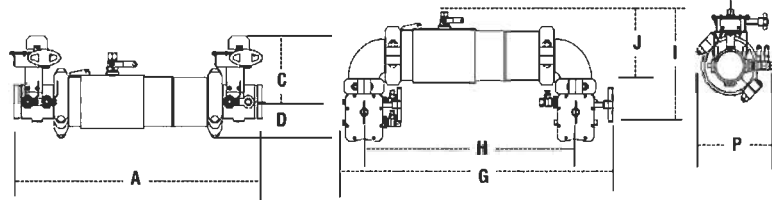

M200aBFG/M200NaBFG

SIZE (DN)	DIMENSIONS								WEIGHT	
	A	C	D	G	H	I	J	P	M200aBFG	M200NaBFG
2 1/2	28	8	3 1/2	29 7/8	22 1/8	14 15/16	8 13/16	9	56	64
3	28 1/2	8 5/16	3 11/16	30 3/4	22 3/4	15 7/16	9 3/16	9 1/2	54	67
4	36	8 11/16	4 13/16	39	30 3/4	18	11 11/16	11	119	142

Flow Curves

* = Rated flow ** = UL Tested

— Horizontal — Vertical - - - - N-Pattern

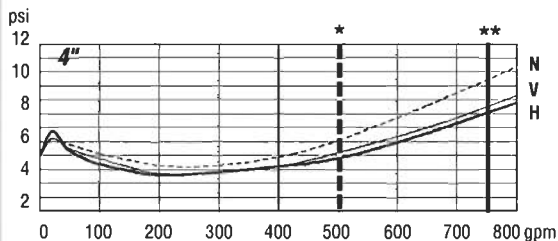
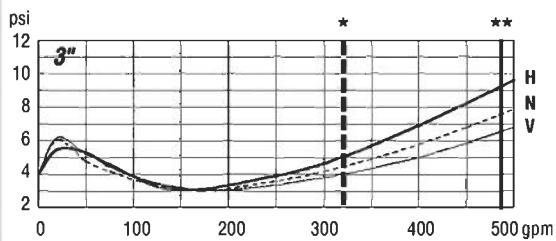
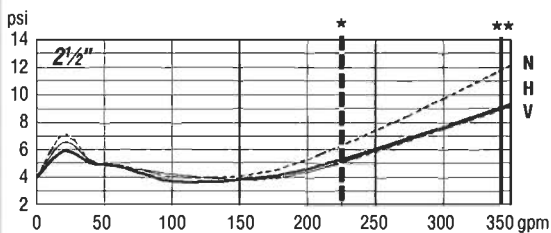

Dimensions — Weights

M300a/M300Na

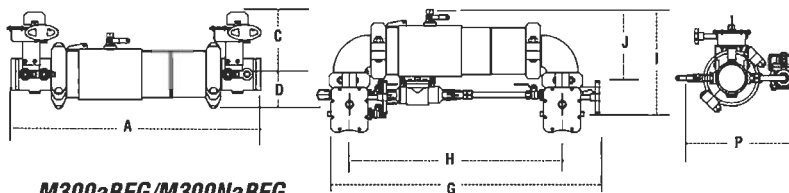

M300aBFG/M300NaBFG

SIZE	DIMENSIONS								WEIGHT	
	A	C	D	G	H	I	J	P	M300aBFG	M300NaBFG
2 1/2	28	8	3 1/2	29 7/8	22 1/8	14 15/16	8 13/16	13	70	78
3	28 1/2	8 5/16	3 11/16	30 3/4	22 3/4	15 7/16	9 3/16	13 1/2	68	81
4	36	8 11/16	4 13/16	39	30 3/4	18	11 11/16	15	133	156

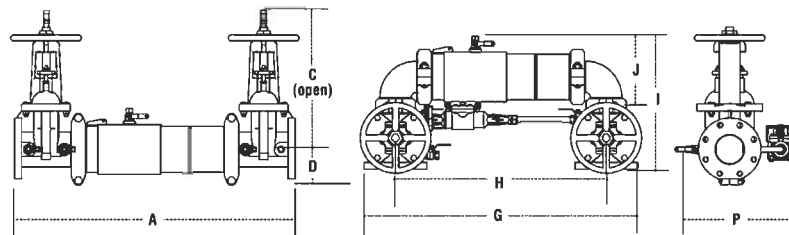

M300a/M300Na

SIZE (DN)	DIMENSIONS								WEIGHT	
	A	C (OSY)	D	G	H	I	J	P	M300a	M300Na
2 1/2	31	16 3/8	3 1/2	29 1/16	22 3/4	15 13/16	8 13/16	13 3/16	139	147
3	31 11/16	18 7/8	3 11/16	30 1/2	22 3/4	17 1/8	9 3/16	14 1/2	159	172
4	40 1/2	22 3/4	5	39 3/4	30 3/4	20 3/8	11 11/16	15 3/16	233	256

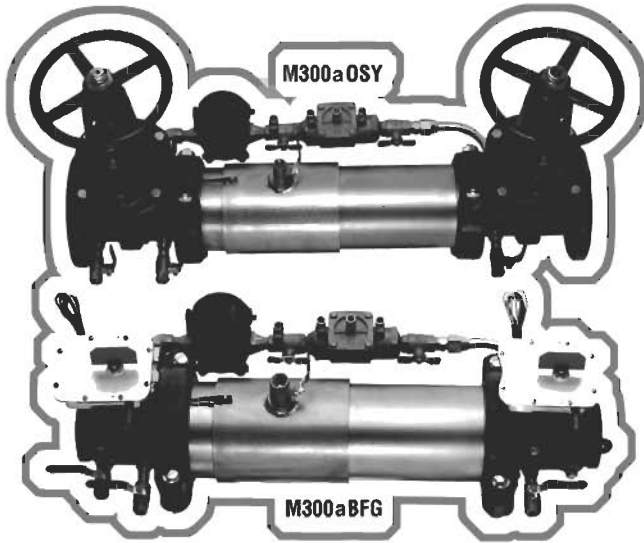

Model M300a / M300Na Double Check Detector Assemblies 2-1/2" to 4"

Models

- OSY - UL/FM outside stem and yoke resilient seated gate valves
- BFG - UL/FM grooved gear operated butterfly valves w/tamper switch



Features

- Extremely Compact Design
- 70% Lighter than Traditional Designs
- 304 (Schedule 40) Stainless Steel Housing & Sleeve
- Groove Fittings Allow Integral Pipeline Adjustment
- Patented Bi-Link Checks Provides Lowest Pressure Loss
- Unmatched Ease of Serviceability
- Available with Grooved Butterfly Valve Shutoffs
- Replaceable Check Disc Rubber

Materials

- Housing & Sleeve: 304 (Schedule 40) Stainless Steel
- Elastomers: EPDM, Silicone and Buna 'N'
- Bi-Link Checks: Noryl®, Stainless Steel
- Check Discs: Reversible EPDM
- Test Cocks: Bronze Body Nickel Plated
- Pins & Fasteners: 300 Series Stainless Steel
- Springs: Stainless Steel

Pressure — Temperature

Temperature Range: 33°F – 140°F
Maximum Working Pressure: 175psi

Approvals

ASSE 1048, UL Listed 28S6, CSA B64.5, FM Approved, USC Approved.

Configurations

- Horizontal
- Vertical up
- "N" pattern horizontal

Specifications

The Maxim M300a/M300Na Double Check Detector Assemblies are used to prevent backflow of pollutants, that are objectionable but not toxic, from entering the potable water supply system. The Maxim M300a/M300Na may be installed under continuous pressure service and may be subjected to backpressure. For use in non-health hazard applications where it is necessary to monitor the unauthorized use of water. The DCDAs shall consist of two independent Bi-Link Check modules within a single housing, sleeve access port, four test cocks and two drip tight shutoff valves. The housing shall be constructed with groove end connections. The bypass assembly features a register meter, double check valve assembly, and the required test cocks.

Installation

The system should be flushed before the valve is installed. The Series M300a/M300Na must be installed in accordance with the direction of the flow arrow on the assembly and according to the local water authority. The assembly should be installed with adequate clearance to allow inspection, testing and servicing. 12" should be the minimum clearance above grade.

MAXIM SERIES

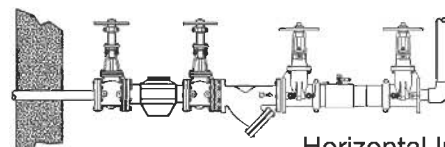

Horizontal Installation

Models 200a/200Na & 300a/300Na Replacement Parts

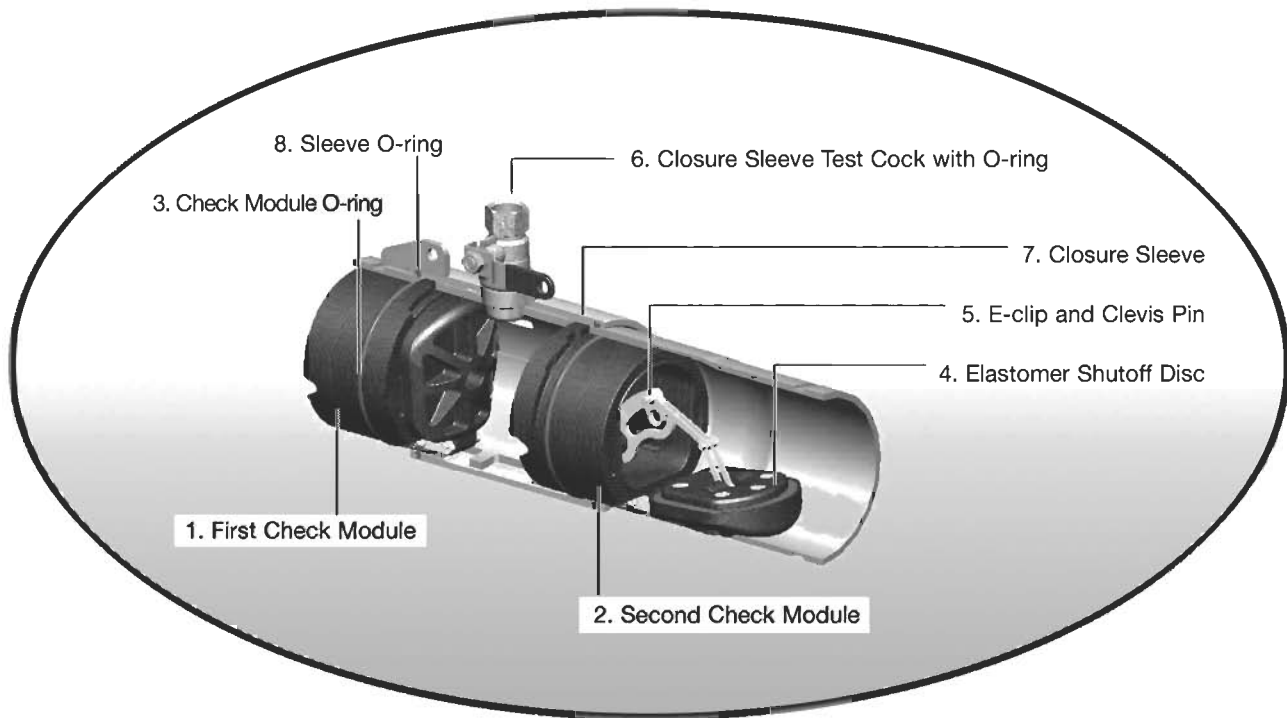

ITEM NO.	PART DESCRIPTION	2 1/2"	3"	4"
1	FIRST CHECK MODULE (a)	7018387	7018387	7018389
2	SECOND CHECK MODULE (a)	7018388	7018388	7018390
3	CHECK MODULE O-RING	7017861	7017861	7017910
4	ELASTOMER SHUTOFF DISC	7018329	7018329	7018330
5	GROOVED CLEVIS PIN KIT (CONTAINS: "E" CLIP & CLEVIS PIN) 5 PER PACK	7018126	7018126	7018127
6	CLOSURE SLEEVE TEST-COCK WITH O-RING	7018152	7018152	7018153
7	CLOSURE SLEEVE	7017880	7017880	7017882
8	SLEEVE O-RING (2 REQ'D)	7017896	7017896	7017921
NS	CHECK REPAIR KIT (CONTAINS: O-RING, SHUTOFF DISC & "E" CLIP)	7018391	7018391	7018392
NS	TEST COCK, .50 FPT X FPT WITH NIPPLE	7018394	7018394	7018394
NS	"E" CLIP	7017870	7017870	7017821
NS	GROOVE COUPLER	7017994	7017995	7017996
NS	O-RING, #3 TEST COCK	7017897	7017897	7017897
NS	STAINLESS STEEL CHECK RETAINER	7018408	7018408	7018409

American Backflow Specialties

www.americanbackflow.com

(800) 66-BKFLO

(619) 527-2525

Fax: (619) 527-2527